



Panel instruments

Conditions of delivery:

Delivery in accordance with General Conditions ECE 188+ addendum. Unless otherwise agreed upon, all equipment is delivered FCA Nyköping, Sweden. Prices can be obtained via quotation or via our price list. We reserve the right to make changes in design and measurements without prior notice.

General descriptions	4
Moving coil instruments	9
Moving coil instruments with rectifier	12
Moving coil instruments, special designs	14
Moving iron instruments	15
Maximum demand ammeters with bimetallic movements	18
Wattmeters	19
Varmeters	21
Power factor meters	22
Watt-, Var-, Power factor meters, special designs	23
Frequency meters	24
Digital panel instruments	25
Position indicators	26
Synchronizing instruments	28
Voltmeters for synchronization	30
Instrument accessories	31
Scale types	32
Dimensions	33
Shunts	34

GENERAL DESCRIPTIONS

Standards

The electrical indicating instruments produced by Cewe Instrument comply with specifications EN60051, DIN 43802, DIN 43700, EN 50081-1, EN 50082-1, EN 50081-2, EN 50082-2, EN 61010-1.

Panel instruments manufactured by Cewe Instrument are CE marked according to Stated Standards above.

Accuracy

The error of a indicating instrument can be divided into an intrinsic error and variations caused by external influence quantities. The intrinsic error consists of errors due to balance, friction or individual variations between instruments. The influence quantities are the ambient temperature, frequency, mounting position, external magnetic fields etc.

As a measure of the instrument's accuracy we use the concept accuracy class, defined in SS IEC 51. The class index states a maximum intrinsic error under certain reference conditions of calibration temperature, mounting position etc. In most cases, error is expressed as a percentage of the upper limit of the measuring range. When zero is displaced within the scale, the error is taken as a percentage of the sum of the upper and lower limit of the measuring range, irrespective of sign. For non-linear scales the error is a percentage of the scale length.

Temperature range

Cewe Instrument indicating instruments are suitable for operation between -25°C and $+50^{\circ}\text{C}$.

Test voltage

All Cewe Instrument's instruments are subjected to a dielectric strength test of 4.3 kV, 50 Hz for 1 minute.

Current and voltage limits

Maximum direct connection current for quadrant scale narrow flange instruments is 60 A for the different types. For higher currents, please use current transformers or shunt respectively. Moving iron ammeters can take a 50-fold current of short duration and voltmeters twice the nominal voltage for a short period.

Housing

Instruments with a narrow flange have cases of polycarbonate.

Bearings

The movements have pivot bearings, with highly polished pivots of hardened steel and sapphire bearings.

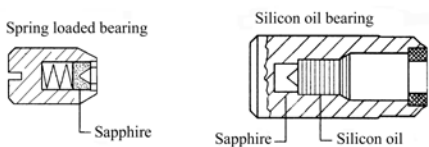

Magnetic shielding

Cewe Instrument's instruments are well shielded and it is not necessary to state in which type of panel the meters will be mounted. In cubicles the moving iron instruments can be mounted in high magnetic fields. Our instruments are designed for these conditions.

Zero adjustment

Most instruments are fitted with a zero-setting knob, by which the zero position of the pointer can be adjusted.

Scales

Cewe Instrument produces indicating instruments with a number of different scale types as shown below:

The quadrant scale is the most common. The movement in the right hand corners well utilised. Scale deflection approx. 90° .



The circular scale utilises the housing well; A long scale is obtained in relation to instrument size. Scale deflection approx. 240° .



Edgewise instruments are common in process and control instrumentation. Scales for these instrument can be horizontal or vertical.



Cewe Instrument's instruments have long scale length in relation to front flange dimensions. They are produced according to DIN 43 802 specifications with black text on a white dial.

On request scales may be produced with yellow text on a black dial. Instruments with such scales have yellow pointers and black casings. The upper limit of the measuring range should preferably be chosen from the following numbers 1, 1.5, 2.5, 4, 6 or multiples or submultiples thereof.

Mounting position

Standard instruments are calibrated for a vertical mounting position. When other mounting positions are required, please state that on the order. The mounting position is related to the horizontal plane according to the figure. Orders for edgewise panel meters should always state whether a horizontal or vertical scale is required. Nominal range of use is $\pm 5^\circ$ from the given mounting position. The additional error in other mounting positions is very small.

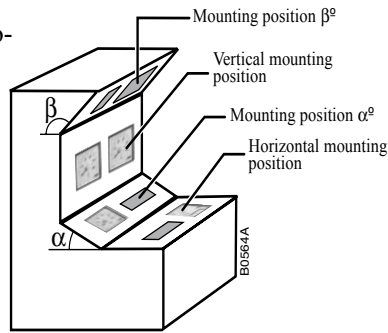

Protection covers

To prevent unintentional contacts with the instrument terminals protection covers are available as an accessory for instruments with front flange dimensions 48 x 48, 72 x 72 and 96 x 96 mm. The cover is snapped onto the rear of the instrument after mounting and connecting the instrument leads.

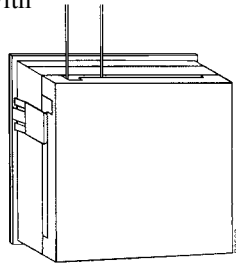

Adjustable red marker

Any instrument with a quadrant scale can be provided with an adjustable red marker. The marker is placed on the inside of the front cover. The purpose is to show a max or min value in the same manner as a red mark on the dial. After removing the front the marker position could easily be changed.

Mounting of the instruments

The instruments are mounted with a snap-in mounting device as shown in the figure. This is a simple, reliable, and very time-saving method. There are no small screws or spring-clips to get lost.

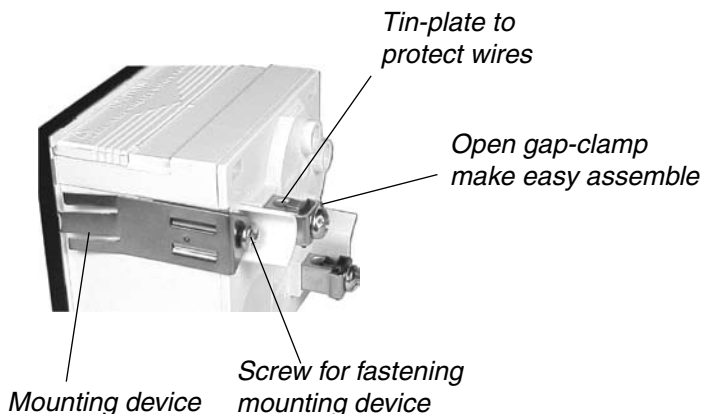

Tropical design

High relative humidity and corrosive environments in general, require good component quality and surface finish. For these environments Cewe Instrument provides instruments with a tropical finish. Most of the instruments described in this catalogue can be delivered in this finish.

The following steps are taken:

- Pivots are lubricated with instrument oil.
- Printed circuit boards are fitted with a protective coating.
- Tin soldering are protected.
- Coils are impregnated.
- All important parts are provided with an corrosive resistant surface finish.

Standard design	Tropical design
Relative humidity max 85% for max 60 days per year.	Relative humidity max 95% for max 30 days per year.
Otherwise max 75%	Otherwise max 85%
Year average max 65%	Year average max 75%

Bumps and vibrations

Our instruments are constructed to withstand strain occurring in all normal applications. All standard design instruments withstand bumps with accelerations of 15 m/s^2 .

In specifications for equipment to be used in areas where earthquakes occur, there are often bump and vibration withstand capability requirements on components. Cewe Instrument fulfil these requirements well.

Protection degree

Standard instruments are made according to IP 54. Instruments mounted in environmental with high density of dust etc. should be made in a sealed version. This sealed version conform to IP 65.

GENERAL DESCRIPTIONS

Moving iron instruments



Cewe Instrument manufactures moving iron instruments with front flange dimensions 48 x 48, 72 x 72 and 96 x 96 mm, all with quadrant scales. These instruments are primarily used for the measurement of A.C. current and A.C. voltage.

Ammeters with a measuring range of 1 A and above are practically frequency independent up to approx. 400 Hz, while voltmeters with their more inductive coils are somewhat more frequency dependent. Therefore it is important to state calibration frequency when other frequencies than 50 – 60 Hz are desired. It should always be noted on the order, when the instruments will be used for the measurement of D.C. quantities. The measuring accuracy is, however somewhat effected by small error due to D.C. magnetisation.

The moving iron instruments have a silicone damping system. The screw containing the sapphire of the bearing is filled with silicone oil and the spindle is thus damped in its

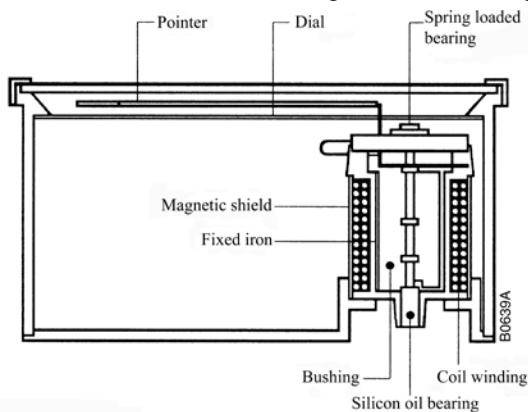

movement. Measures are taken that the silicone oil cannot creep out of the screw. The oil viscosity temperature coefficient is low and damping properties almost constant within the whole temperature range $-25^{\circ} - + 50^{\circ}\text{C}$. By varying the viscosity of the oil, the damping properties can be chosen after application. If special damping properties are required, this should be specified on order.

Cewe Instruments moving iron instruments are characterised by low power consumption, high torque (low effect on friction) and a linear scale from approx. 20% of the measuring range.

The power consumption for C.T. connected ammeters is 0.55 VA for 1 Amp C.T.s. and 0.65 VA for 5 Amp C.T.s.

Order information required:

1. Type of instrument, e.g. IQ 96.
2. Measuring range, e.g. 0 – 25 A.
3. Transformer when applicable e.g. 100/5 A.
4. Special design, e.g. red mark at 15 A

Order example:

2 pcs. IQ 72, 100/5 A scale 0 – 120 A. Red mark at 75 A.

Overload

$1.2 \times U_{IN}$ continuously, $2 \times U_{IN}$ during 5 s,

$2 \times I_{IN}$ continuously, $10 \times I_{IN}$ during 10 s.

Transformer connected moving iron ammeters withstand $50 \times I_{N1}$ sec.

Maximum demand ammeters



Maximum demand ammeters with bimetal movements are used for the supervision of thermal load in transformers cables, motors etc. The thermal lag for the bimetal system is 15 minutes, 8 minutes on request.

The torque of the meter movement is great and its black pointer can move a red slave pointer, the position of which indicates the highest average value of the current. The slave pointer can be returned to the position of the black pointer with a special re-set knob.

The instrument can be connected to 5 A circuit, to a C.T. $\times/5$ A or $\times/1$ A. Upper limit of measuring range is 20% of rated value,

Maximum demand ammeters are also available in combination with a moving iron ammeter.

Overload

$2 \times I_{IN}$ continuously

$10 \times I_{IN}$ for 10 s

Types QB 72/96 and IQB 96 also available with built in saturating transformer as an option.

Moving coil instruments

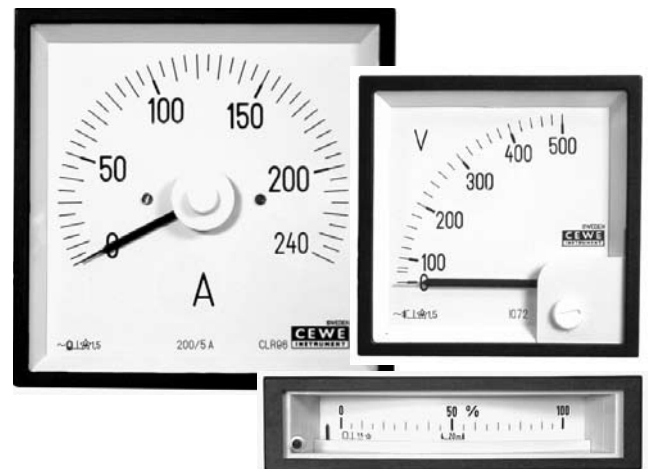

Moving coil instruments are used for measurement of D.C. current and D.C. voltage. The movements have low power consumption and an approximately linear scale. Provided with a rectifier, the moving-coil instruments can be used for the measurement of sinusoidal A.C. current and A.C. voltage. In this case, the movement is average sensing, but the scale is graduated in r.m.s. The moving coil rectifier instrument is used where there are requirements for low power consumption (a linear scale from zero) or for measurements at high or varying frequencies.

The standard voltmeters have 1 mA current consumption, but can in most cases be produced for 100 μ A current consumption.

Millivoltmeters for connection to shunts are calibrated for a connection lead resistance of 0.035 Ω .

Cewe Instrument's moving coil instruments have pivot-bearings and high torque.

These instruments are of three different types:

1. Quadrant scale, 90° deflection, see page 32
2. Circular scale, 240° deflection, see page 32
3. Edgewise, 70° deflection, see page 32

Information required with order:

1. Type of instrument, e.g. CQ 96
2. Measuring range, e.g. 0 – 250 V
3. Shunt data when applicable, e.g. 100 A, 60 mV
4. Any kind of special design, e.g. tropical design

Order example:

1 pcs CL 96, 0 – 20 mA, scale 0 – 250 kW, red mark at 200 kW.

Overload

$1.2 \times U_{IN}$ continuously, $2 \times U_{IN}$ during 5 s,

$2 \times I_{IN}$ continuously, $10 \times I_{IN}$ during 10 s.

GENERAL DESCRIPTIONS

Frequency meters



The pointer frequency meter is fitted with a transducer combined with a moving coil movement, can be chosen with front flange dimensions 72 x 72 mm and 96 x 96 mm. If other sizes and designs are required, we recommend moving coil instruments in combination with Cewe Instrument's measuring transducers, e.g. DF 03.

Power and power factor meters



Cewe Instruments watt, var and power factor meters incorporate a transducer feeding a moving coil meter. This produces a very solid and vibrationproof instrument. The light moving coil movement with spring loaded bearings can endure a great mechanical stress. Transducers operating in accordance with the TDM-principle (Time Division Multiplication) measure with an extreme accuracy even with a non-sinusoidal waveform. All types of var- and wattmeters can be ordered for one or two voltage directions.

Example: One direction 0 – 20 mW
Two directions 20 – 0 – 20 mW

Overload

1.2 x U_{IN} continuously, 2 x U_{IN} during 5 s,
2 x I_{IN} continuously, 10 x I_{IN} during 10 s.

MOVING COIL INSTRUMENTS



Type		CQ 48	CQ 72	CQ 96
Front flange	mm	48 x 48	72 x 72	96 x 96
Housing	mm	45 x 45	67 x 67	91 x 91
Scale		linear	linear	linear
Scale length	mm	34	67	103
Class		2.5	1.5	1.5
Response time	sec	1	1	1
Test voltage	V~	4300	4300	4300
Weight	kg	0.12	0.16	0.20

Ammeters

Measuring range	CQ 48	CQ 72	CQ 96
	ΔU ca mV		
100 μ A	130	130	130
150 μ A	190	190	190
250 μ A	120	120	120
400 μ A	130	130	130
600 μ A	105	105	105
1 mA	55	55	55
1.5 mA	35	35	35
2.5 mA	25	25	25
4 mA	25	25	25
6 mA	25	25	25
10 mA	30	30	30
15 mA	60	60	60
20 mA	60	60	60
4-20 mA	60	60	60
25 mA	60	60	60
40 mA	60	60	60
60 mA	60	60	60
100 mA	60	60	60
150 mA	60	60	60
250 mA	60	60	60
400 mA	60	60	60
600 mA	60	60	60
1 A	60	60	60
1.5 A	60	60	60
2.5 A	60	60	60
4 A	60	60	60
6 A	60	60	60
10 A	60	60	60
15 A	60	60	60
25 A	60	60	60
Sep. shunt *)	60	60	60

Voltmeters

Measuring range	CQ 48	CQ 72	CQ 96
	R_i ca Ω/V		
60 mV	500	500	500
100 mV	500	500	500
150 mV	500	500	500
250 mV	500	500	500
400 mV	1000	1000	1000
600 mV	1000	1000	1000
1 V	1000	1000	1000
1.5 V	1000	1000	1000
2.5 V	1000	1000	1000
4 V	1000	1000	1000
6 V	1000	1000	1000
10 V	1000	1000	1000
15 V	1000	1000	1000
25 V	1000	1000	1000
40 V	1000	1000	1000
60 V	1000	1000	1000
100 V	1000	1000	1000
150 V	1000	1000	1000
250 V	1000	1000	1000
400 V	1000	1000	1000
500 V	1000	1000	1000
600 V	1000	1000	1000

*) Voltage drop $\pm 1.5\%$. current consumption approx 2 mA.

MOVING COIL INSTRUMENTS



Type		CL 48	CL 72	CL 96
Front flange	mm	48 x 48	72 x 72	96 x 96
Housing	mm	45 x 45	67 x 67	91 x 91
Scale		linear	linear	linear
Scale length	mm	67	110	151
Class		1.5	1.5	1.5
Response time	sec	1	1	1
Test voltage	V~	4300	4300	4300
Weight	kg	0.25	0.25	0.30

Ammeters

Measuring range	CL 48	CL 72	CL 96
	ΔU ca mV		
600 mA	500	500	500
1 mA	345	345	345
1.5 mA	260	260	260
2.5 mA	250	250	250
4 mA	200	200	200
6 mA	80	80	80
10 mA	80	80	80
15 mA	80	80	80
20 mA	80	80	80
4-20 mA	80	80	80
25 mA	150	150	150
40 mA	150	150	150
60 mA	150	150	150
100 mA	150	150	150
150 mA	150	150	150
250 mA	150	150	150
400 mA	150	150	150
600 mA	150	150	150
1 A	150	150	150
1.5 A	150	150	150
2.5 A	150	150	150
4 A	–	–	150
6 A	–	–	150
10 A	–	–	150
15 A	–	–	150
25 A	–	–	150
Sep. shunt *)	(60)150	(60)150	(60) 150

Voltmeters

Measuring range	CL 48	CL 72	CL 96
	R_i ca Ω/V		
60 mV	100	100	100
100 mV	100	100	100
150 mV	100	100	100
250 mV	100	100	100
400 mV	100	100	100
600 mV	100	100	100
1 V	1000	1000	1000
1.5 V	1000	1000	1000
2.5 V	1000	1000	1000
4 V	1000	1000	1000
6 V	1000	1000	1000
10 V	1000	1000	1000
15 V	1000	1000	1000
25 V	1000	1000	1000
40 V 1000	1000	1000	
60 V	1000	1000	1000
100 V	1000	1000	1000
150 V	1000	1000	1000
250 V	1000	1000	1000
400 V	1000	1000	1000
500 V	1000	1000	1000
600 V	–	–	1000

*) Voltage drop $\pm 1.5\%$. current consumption approx 6.6 mA.

MOVING COIL INSTRUMENTS



Type		MP 48x24	MP 72x24	P 96 PrS
Front flange	mm	48 x 24	72 x 24	96 x 48
Housing	mm	43 x 17 x 75	66 x 17 x 98	91 x 43 x 107
Cut out	mm	45 x 22.2	68 x 22.2	92 x 45
Scale		linear	linear	linear
Scale length	mm	32	52	67
Class		1.5	1.5	1.5
Response time	sec	1	1	1
Test voltage	V~	4300	4300	4300
Weight	kg	0.1	0.2	0.45

Ammeters

Measuring range	MP 48x24	MP 72x24	P 96 PrS
	ΔU ca mV		
100 μ A	1000 Ω	680 Ω	4900 Ω
150 μ A	835 Ω	480 Ω	3600 Ω
250 μ A	500 Ω	300 Ω	2200 Ω
400 μ A	310 Ω	205 Ω	1300 Ω
600 μ A	210 Ω	110 Ω	250 Ω
1 mA	32 mV	31 Ω	48 Ω
1.5 mA	46 mV	24 Ω	60 mV
2.5 mA	46 mV	20 Ω	60 mV
4 mA	46 mV	17 Ω	60 mV
6 mA	46 mV	60 mV	60 mV
10 mA	46 mV	60 mV	60 mV
15 mA	46 mV	60 mV	60 mV
20 mA	46 mV	60 mV	60 mV
4-20 mA	46 mV	60 mV	60 mV
25 mA	46 mV	60 mV	60 mV
40 mA	46 mV	60 mV	60 mV
60 mA	46 mV	60 mV	60 mV
100 mA	46 mV	60 mV	60 mV
150 mA	46 mV	60 mV	60 mV
250 mA	46 mV	60 mV	60 mV
400 mA	46 mV	60 mV	60 mV
600 mA	46 mV	60 mV	60 mV
1 A	46 mV	60 mV	60 mV
Sep. shunt *)	60 mV	60 mV	60 mV

*) Voltage drop $\pm 1.5\%$

Other versions on request.

Voltmeters

Measuring range	MP 48x24	MP 72x24	P 96 PrS
	R_i ca Ω/V		
1 V	1000	1000	1000
1.5 V	1000	1000	1000
2.5 V	1000	1000	1000
4 V	1000	1000	1000
6 V	1000	1000	1000
10 V	1000	1000	1000
15 V	1000	1000	1000
25 V	1000	1000	1000
40 V	1000	1000	1000
60 V	1000	1000	1000
100 V	1000	1000	1000
150 V	1000	1000	1000
250 V	1000	1000	1000
400 V	1000	1000	1000
500 V	1000	1000	1000
600 V	1000	1000	1000

MOVING COIL INSTRUMENTS WITH RECTIFIER



Type		CQR 48	CQR 72	CQR 96
Front flange	mm	48 x 48	72 x 72	96 x 96
Housing	mm	45 x 45	67 x 67	91 x 91
Scale		linear	linear	linear
Scale length	mm	34	67	103
Class		2.5	1.5	1.5
Response time	sec	1	1	1
Test voltage	V~	4300	4300	4300
Weight	kg	0.13	0.17	0.37

Moving coil instruments with rectifier are intended for sinusoidal A.C.

40 – 10.000 Hz. Measuring ranges from 25 V upwards have a linear deflection. Ranges below 25 V have the first part of the scale slightly compressed.

Ammeters

Measuring range	CQR 48	CQR 72	CQR 96
	ΔU ca V		
400 mA	1.3	1.3	1.3
600 mA	1.3	1.3	1.3
1 mA	1.3	1.3	1.3
1.5 mA	1.3	1.3	1.3
2.5 mA	1.3	1.3	1.3
4 mA	1.3	1.3	1.3
6 mA	1.4	1.4	1.4
10 mA	1.4	1.4	1.4
15 mA	1.4	1.4	1.4
25 mA	1.5	1.5	1.5
40 mA	1.5	1.5	1.5
60 mA	1.5	1.5	1.5
100 mA	1.6	1.6	1.6
150 mA	0.25	0.25	0.25
250 mA	0.2	0.2	0.2
400 mA	0.15	0.15	0.15
600 mA	0.12	0.12	0.12
1 A	0.1	0.1	0.1
X/1 A*	0.1	0.1	0.1
X/5 A*	0.05	0.05	0.05

*) For instrument transformer, transformer data to be given.

Voltmeters

Measuring range	CQR 48	CQR 72	CQR 96
	R_i ca Ω/V		
6 V	1000	1000	1000
10 V	1000	1000	1000
15 V	1000	1000	1000
25 V	1000	1000	1000
40 V	1000	1000	1000
60 V	1000	1000	1000
100 V	1000	1000	1000
150 V	1000	1000	1000
250 V	1000	1000	1000
400 V	1000	1000	1000
500 V	–	1000	1000
600 V	–	1000	1000
X/110V*	1000	1000	1000

*) For instrument transformer, transformer data to be given.

MOVING COIL INSTRUMENTS WITH RECTIFIER



Type		CLR 48	CLR 72	CLR 96
Front flange	mm	48 x 48	72 x 72	96 x 96
Housing	mm	45 x 45	67 x 67	91 x 91
Scale length	mm	67	110	151
Class		2.5	1.5	1.5
Response time	sec	1	1	1
Test voltage	V~	4300	4300	4300
Weight	kg	0.3	0.3	0.35

Ammeters

Measuring range	CLR 48	CLR 72	CLR 96
	ΔU ca V		
1 mA	1.3	1.3	1.3
1.5 mA	1.3	1.3	1.3
2.5 mA	1.3	1.3	1.3
4 mA	1.3	1.3	1.3
6 mA	1.4	1.4	1.4
10 mA	1.4	1.4	1.4
15 mA	1.4	1.4	1.4
25 mA	1.5	1.5	1.5
40 mA	1.5	1.5	1.5
60 mA	1.5	1.5	1.5
100 mA	1.6	1.6	1.6
150 mA	0.25	0.25	0.25
250 mA	0.25	0.25	0.25
400 mA	0.25	0.25	0.25
600 mA	0.25	0.25	0.25
1 A	0.1	0.1	0.1
X/1 A*	0.1	0.1	0.1
X/5 A*	0.05	0.05	0.05

Voltmeters

Measuring range	CLR 48	CLR 72	CLR 96
	R_i ca Ω/V		
6 V	1000	1000	1000
10 V	1000	1000	1000
15 V	1000	1000	1000
25 V	1000	1000	1000
40 V	1000	1000	1000
60 V	1000	1000	1000
100 V	1000	1000	1000
150 V	1000	1000	1000
250 V	1000	1000	1000
400 V	1000	1000	1000
500 V	1000	1000	1000
600 V	–	–	1000
X/110V*	1000	1000	1000

*) For instrument transformer, transformer data to be given.

*) For instrument transformer, transformer data to be given.

MOVING COIL INSTRUMENTS, SPECIAL DESIGNS

Special designs

General

- Adjustable red marker
- Non-reflecting front cover

Movement

- Non-standard measuring range
- Non-standard mounting position (see page 5)
- Mechanically suppressed zero
- Zero displaced within scale
- Voltmeter with extra ohm scale
- Extra measuring range
- Specified internal resistance ($\pm 1.5\%$ or $\pm 1\%$)
- Built-in trimpotentiometer max $\pm 25\%$ of rated voltage
- Voltmeter with higher internal resistance
- Accuracy class 1.0 (if possible)
- Calibration of rectifier instruments for specified frequencies up to 10 kHz
- Calibration for specified connection lead resistance for instruments with separate shunts
- Earth indication voltmeter
- Tropical design

Scale

- Red mark at a special value
- Colour field
- Double figures
- Double divisions
- Black dial and yellow figures, divisions and pointer
- Non-standard graduation
- Calibration according to graph or table
- Extra text on scale

MOVING IRON INSTRUMENTS



Type		IQ 48	IQ 72	IQ 96
Front flange	mm	48 x 48	72 x 72	96 x 96
Housing	mm	45 x 45	67 x 67	91 x 91
Class		2.5	1.5	1.5
Scale length	mm	34	67	103
Frequency range	Hz	15-100	15-100	15-100
Test voltage	V~	4300	4300	4300
Weight	kg	0.10	0.15	0.22

Ammeters

Measuring range	IQ 48	IQ 72	IQ 96
	ΔU ca mV		
250 mA	2000	2000	2000
400 mA	1850	1850	1850
600 mA	1200	1200	1200
1 A	800	800	800
1.5 A	400	400	400
2.5 A	330	330	330
4 A	200	200	200
6 A	130	130	130
10 A	130	130	130
15 A	80	80	80
25 A	55	55	55
40 A	–	30	30
60 A	–	40	40
X/1 A*	550	550	550
X/5 A*	130	130	130

*) For instrument transformer, transformer data to be given.

Scales are manufactured with 20% overrange e. g. C.T. 100/5 A, scale 0-120 A.

Voltmeters

Measuring range	IQ 48	IQ 72	IQ 96
	R_i ca Ω/V		
6 V	4	4	4
10 V	10	10	10
15 V	10	10	10
25 V	20	20	20
40 V	25	25	25
60 V	35	35	35
100 V	40	40	40
150 V	50	50	50
250 V	90	90	90
400 V	150	150	150
500 V	150	150	150
600 V	150	150	150
800 V	–	200	200
X/100 V*	40	40	40
X/110 V*	40	40	40

*) For instrument transformer, transformer data to be given.

Voltmeters scaled for use with following V.T's are normally in stock:

Type	IQ 48	IQ 72	IQ 96
3300/110 V skala 0 – 4 kV			X
4400/110 V skala 0 – 5 kV			X
6600/110 V skala 0 – 7 kV	X	X	X
11000/110 V skala 0 – 12 kV	X	X	X
11000/110 V skala 0 – 15 kV	X	X	X
22000/110 V skala 0 – 25 kV	X	X	X
33000/110 V skala 0 – 40 kV			X
44000/110 V skala 0 – 50 kV			X

MOVING IRON INSTRUMENTS

Instruments for connection to the following C.T.'s are normally in stock.

Measuring range	IQ 48	IQ 72	IQ 96
2/1 A	X	X	
2.5/1 A	X	X	
5/1 A	X	X	
10/1 A	X	X	
15/1 A	X	X	X
20/1 A	X	X	
25/1 A	X	X	X
30/1 A	X	X	
50/1 A	X	X	X
75/1 A	X	X	X
100/1 A	X	X	X
150/1 A	X	X	X
200/1 A	X	X	X
300/1 A	X	X	X
400/1 A	X	X	X
500/1 A	X	X	
600/1 A	X	X	X
800/1A	X	X	X
1000/1A	X	X	X
10/5 A			X
25/5 A	X	X	X
50/5 A	X	X	X
75/5 A	X	X	X
100/5A	X	X	X
150/5 A	X	X	X
200/5 A	X	X	X
250/5 A	X	X	X
300/5 A	X	X	X
400/5 A	X	X	X
500/5 A	X	X	X
600/5 A	X	X	X
750/5 A			X
800/5 A	X	X	X
1000/5 A	X	X	X
1200/5A	X	X	X
1500/5 A	X	X	X
1600/5 A		X	X
2000/5 A	X	X	X
2400/5 A			X
2500/5 A	X	X	X
3000/5 A			X

Special designs

General

- Adjustable red marker
- Non reflecting front cover
- Tropical design

Movement

- Current coil 2 or 10 A for use with transformer
- Non-standard measuring range
- Non-standard mounting position (see page 5)
- Extra damping
- Calibration for certain frequency:
- Ammeter up to 5 kHz
- Voltmeters up to 1 kHz

Scale

- Red mark at a special value
- Colour figures
- Double figures
- Black dial and yellow figures, divisions and pointer
- Extended or compressed scale
- Non-standard graduation
- Calibration according to graph or table
- Extra text on scale
- Overload scale (3x)

MAXIMUM DEMAND AMMETERS WITH BIMETALLIC MOVEMENTS



QB 96



IQB 72

Maximum demand ammeters QB 48, QB 72 and QB 96 have a bi-metal movement with a thermal lag of 15 minutes. Types IQB 72 and IQB 96 contain the same movement and also a moving iron movement.

Type		QB 48	QB 72	IQB 72	QB 96	IQB 96
Front flange	mm	48 x 48	72 x 72	72 x 72	96 x 96	96 x 96
Housing	mm	45 x 45	67 x 67	67 x 67	91 x 91	91 x 91
Scale length, moving iron movement	mm	–	–	43	–	68
Scale length, bi-metallic movement	mm	37	67	67	103	103
Class:						
moving iron movement		–	–	1.5	–	1.5
bi-metallic movement –20 – +40°C		3	3	3	3	3
Angle of deflection:						
moving iron movement		–	–	80°	–	81°
bi-metallic movement		90°	90°	90°	90°	90°
Power consumption:						
moving iron at 1 and 5 A	VA	–	–	0.6	–	0.6
bi-metallic at 1 and 5 A	VA	1.5	1.5	1.5	1.5	1.5
Setting time:						
moving iron	sek	–	–	1	–	1
bi-metallic	min	15/8	15/8	15/8	15/8	15/8
Frequency range	Hz	15-100	15-100	15-100	15-100	15-100
Test voltage	V ~	4300	4300	4300	4300	4300
Weight	ca kg	0.22	0.25	0.35	0.33	0.40

Measuring range	Transformer ratio		Measuring range	Transformer ratio	
0 – 6 A	–	5/1 A	0 – 1.2 kA	1000/5 A	1000/1 A
0 – 30 A	25/5 A	25/1 A	0 – 1.45 kA	1200/5 A	1200/1 A
0 – 60 A	50/5 A	50/1 A	0 – 1.5 kA	1250/5 A	1250/1 A
0 – 90 A	75/5 A	75/1 A	0 – 1.8 kA	1500/5 A	1500/1 A
0 – 120 A	100/5 A	100/1 A	0 – 1.9 kA	1600/5 A	1600/1 A
0 – 180 A	150/5 A	150/1 A	0 – 2.4 kA	2000/5 A	2000/1 A
0 – 240 A	200/5 A	200/1 A	0 – 2.9 kA	2400/5 A	2400/1 A
0 – 300 A	250/5 A	250/1 A	0 – 3 kA	2500/5 A	2500/1 A
0 – 360 A	300/5 A	300/1 A	0 – 3.6 kA	3000/5 A	3000/1 A
0 – 480 A	400/5 A	400/1 A	0 – 3.8 kA	3200/5 A	3200/1 A
0 – 600 A	500/5 A	500/1 A	0 – 4.8 kA	4000/5 A	4000/1 A
0 – 720 A	600/5 A	600/1 A			
0 – 900 A	750/5 A	750/1 A			
0 – 960 (950) A	800/5 A	800/1 A			

Above mentioned ranges normally held on stock.
(Not applicable for QB 48 x/1 A).

WATTMETERS



PL



PQ

Type		PL 12/PQ 12	PL 13/PQ 13	PL14/PQ 14
Front flange	mm	96 x 96	96 x 96	96 x 96
Housing	mm	91 x 91	91 x 91	91 x 91
Scale length	mm	151/103	151/103	151/103
Class		1.5	1.5	1.5
Frequency range	Hz	40-65	40-65	40-65
Response time	sec	1	1	1
Power consumption:				
Current circuit at 5 A	VA	0.4	0.4	0.4
Voltage circuit at 110 V	VA	1.0	1.0	1.0
Test voltage	V~	4300	4300	4300
Weight	kg	0.6	0.6	0.6

Usually made for

Nominal current	5 A
Nominal voltage	PL 12, PQ 12, PL 13, PQ 13: 100 V, 110 V, 230 V, 400 V, 500 V
Nominal voltage	PL 14, PQ 14: 100/57 V, 110/63,5 V, 230/130 V, 400/230 V, 500/290V
The instruments can also be made for currents	1 A, 2 A, 10 A.

Measuring range is limited by: $\frac{\text{Scale power (W)}}{\text{Nominal power (W)}} = \text{min } 0.6 - \text{max } 1.5$

Wiring diagrams

PL 12, PQ 12

Single-phase A.C.

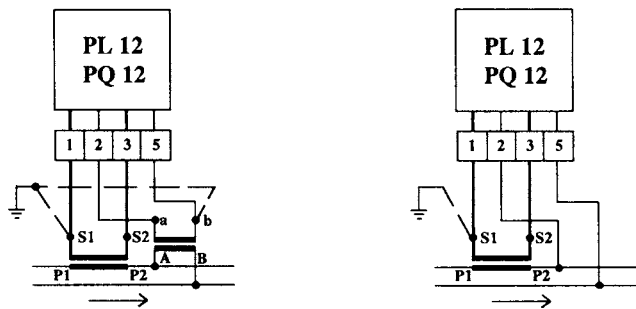

PL 13, PQ 13

3-phase, 3-wire balanced load.

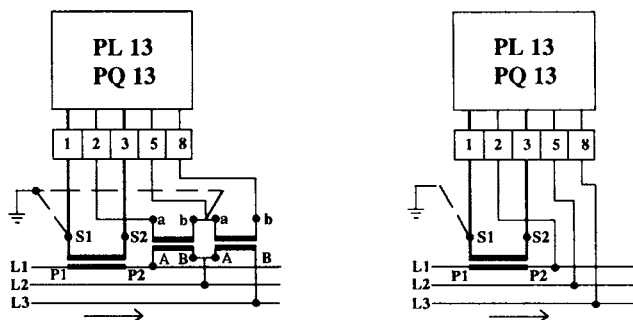

PL 14, PQ 14

3-phase, 4-wire balanced load.

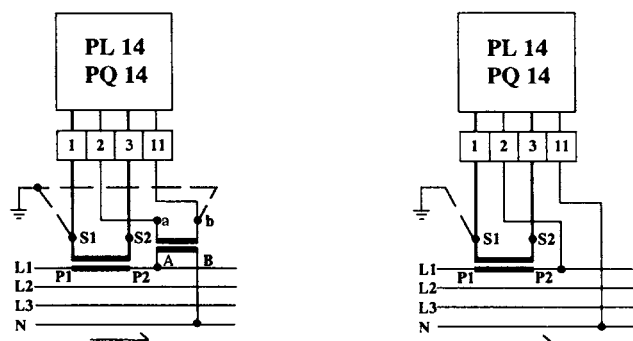

WATTMETERS



PL



PQ

Type		PL 23/PQ 23	PL 33/PQ 33	PL 34/PQ 34
Front flange	mm	96 x 96	96 x 96	96 x 96
Housing	mm	91 x 91	91 x 91	91 x 91
Scale length	mm	151/103	151/103	151/103
Class		1.5	1.5	1.5
Frequency range	Hz	40-65	40-65	40-65
Response time	sec	1	1	1
Power consumption:				
Current circuit at 5 A	VA	0.4	0.4	0.4
Voltage circuit at 110 V	VA	1.0	1.0	1.0
Test voltage	V~	4300	4300	4300
Weight		0.6	0.6	0.6

Usually made for

Nominal current: 5 A
 Nominal voltage: **PL 23, PQ 23, :** 100 V, 110 V, 230 V, 400 V, 500 V
PL 33-34, PQ 33-34: 100/57 V, 110/63,5 V, 230/130 V, 400/230 V, 500/290 V

The instruments can also be made for currents: 1 A, 2 A, 10 A.

PL and PQ can both be ordered for one or two current directions.

$$\text{Measuring range is limited by: } \frac{\text{Scale power (W)}}{\text{Nominal power (W)}} = \text{min 0.6} - \text{max 1.5}$$

Wiring diagrams

PL 23, PQ 23

3-phase, 3-wire unbalanced load.

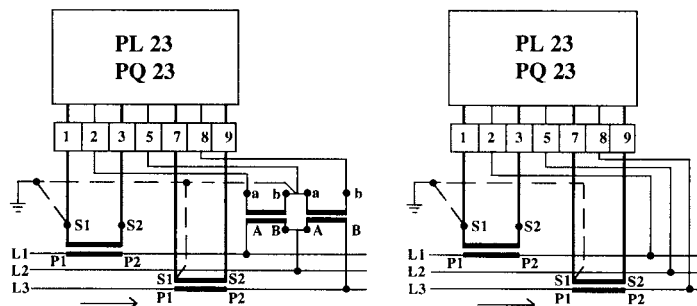

PL 33, PQ 33

3-phase, 4-wire unbalanced load, without neutral.

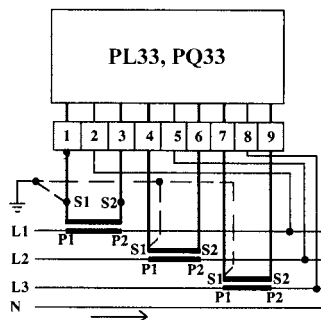

PL 34, PQ 34

3-phase, 4-wire unbalanced load, with neutral

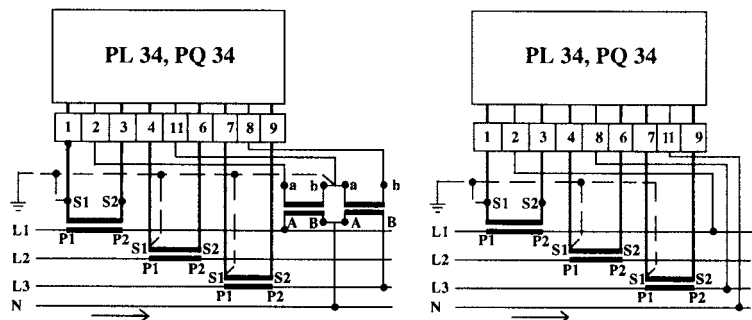



QL



QQ

Type		QL 13/QQ 13	QL 23/QQ 23	QL 33/QQ 33
Front flange	mm	96 x 96	96 x 96	96 x 96
Housing	mm	91 x 91	91 x 91	91 x 91
Scale length	mm	151/103	151/103	151/103
Class		1.5	1.5	1.5
Frequency range	Hz	40-65	40-65	40-65
Response time	sec	1	1	1
Power consumption:				
Current circuit at 5 A	VA	0.4	0.4	0.4
Voltage circuit at 110 V	VA	1.0	1.0	1.0
Test voltage	V~	4300	4300	4300
Weight	kg	0.6	0.6	0.6

Usually made for

Nominal current	5 A
Nominal voltage	QL 13, QQ 13, QL 23, QQ 23: 100 V, 110 V, 230 V, 400 V, 500 V
Nominal voltage	QL 33, QQ 33: 100/57 V, 110/63,5 V, 230/130 V, 400/230 V, 500/290V

The instruments can also be made for currents 1 A, 2 A, 10 A.

QL and QQ can both be ordered for one or two current directions.

$$\text{Measuring range is limited by: } \frac{\text{Scale power (W)}}{\text{Nominal power (W)}} = \text{min 0.6} - \text{max 1.5}$$

Wiring diagrams

QL 13, QQ 13

3-phase, 3-wire balanced load..

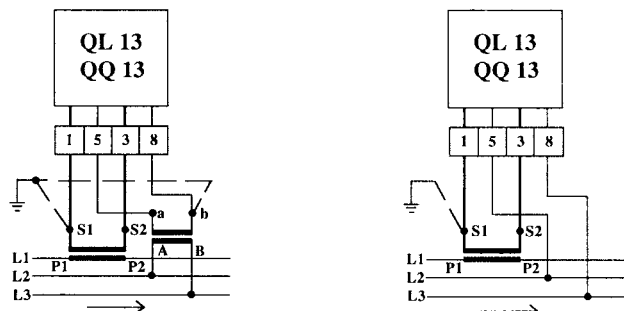

QL 23, QQ 23

3-phase, 3-wire unbalanced load.

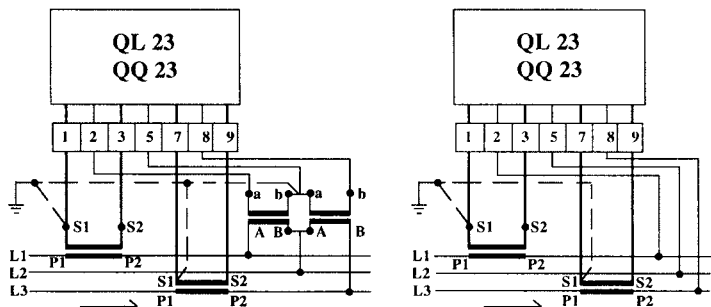

QL 33, QQ 33

3-phase, 4-wire unbalanced load.

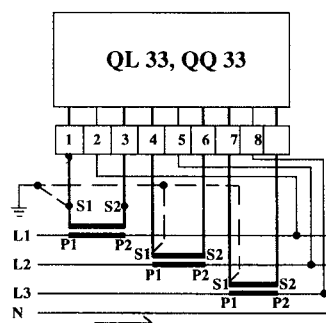

POWER FACTOR METERS



PFL



PFQ

Typ		PFL 12/PFQ 12	PFL 13/PFQ 13
Front flange	mm	96 x 96	96 x 96
Housing	mm	91 x 91	91 x 91
Scale length	mm	151/103	151/103
Class		1.5	1.5
Frequency range	Hz	40-65	40-65
Power consumption:			
Current circuit at 5 A	VA	1.3	1.3
Voltage circuit at 110 V	VA	0.8	0.8
Test voltage	V~	4300	4300
Weight	ca kg	0.42	0.42

Usually made for	
Nominal current	1 A, 2 A, 5 A
Nominal voltage	110 V, 230 V, 400 V, 500 V
Scale CAP-IND	0.5 – 1 – 0.5

Wiring diagrams

PFL 12/PFQ 12

Single-phase

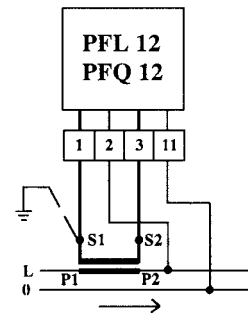
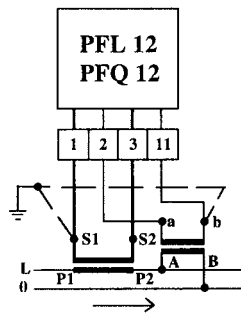

PFL 13/PFQ 13

3-phase, 3-wire balanced load.

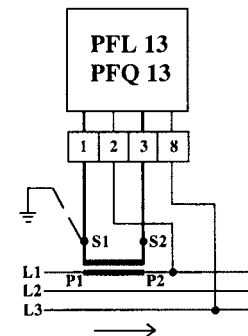
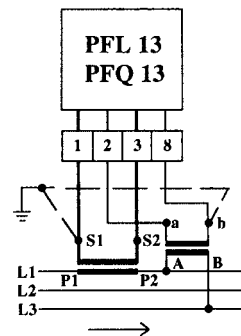

WATT-, VAR-, POWER FACTOR METERS, SPECIAL DESIGNS

Special designs

General

- Adjustable red marker
- Non reflecting front cover

Movement

- Non-standard measuring range
- Non-standard mounting position (see page 5)
- Zero displaced within scale
- Current 10 A
- Tropical design

Scale

- Red mark at a special value
- Colour field
- Double figures
- Double divisions
- Black dial and yellow figures, divisions and pointer
- Non-standard graduation
- Extra text on scale

FREQUENCY METERS



Typ		FQ 72	FQ 96	FL 96
Front flange	mm	72 x 72	96 x 96	96 x 96
Housing	mm	67 x 67	91 x 91	91 x 91
Scale		linear	linear	linear
Scale length	mm	67	103	151
Class		1.5	1.5	1.5
Power consumption	mA	10	10	10
Response time	sec	2	2	2
Test voltage	V~	4300	4300	4300
Weight	kg	0.16	0.2	0.3

Voltage	Measuring range
110 V	46 – 54 Hz
	56 – 64 Hz
	375 – 425 Hz
230 V	46 – 54 Hz
	56 – 64 Hz
	375 – 425 Hz
400 V	46 – 54 Hz
	56 – 64 Hz
	75 – 425 Hz

DIGITAL PANEL INSTRUMENTS



AC inputs

Both AC Voltage and Current circuits are average sensing RMS calibrated. The input signal is transformed to a low level of AC. The transformer secondary voltage is fed to a precision active rectifier, the resulting DC signal is presented to an analogue to digital A/D. The resulting digital information is used to drive the LED display.

DC inputs

DC Voltage and Current inputs are fed into high stability ranging components. The ranging components reduce the input signal to a 2 Volt level. The 2 Volt signal is then presented to the A/D converter which provides the digital information to drive the LED display.

Frequency inputs

A Frequency to Voltage F/V converter is used to convert the input signal to a DC signal. The resulting DC signal is fed in to the A/D converter and the same process as in the AC and DC circuits described above takes place.

Customer adjustment of both "Zero" and "Span" is permissible via potentiometers, accessible from the rear of the product.

Access to the "ZERO" and "SPAN" adjustment. Remove terminal blanks in position 9 & 10. ZERO = 10 SPAN = 9.
Optional externally selectable decimal point. 16 = common
15 = 1.999
14 = 19.99
13 = 199.9

Enclosure

DIN case	Dimensions 96 x 48 x 98 mm
Material	Black polycarbonate
Enclosure code	IP 54 NEMA 12
Terminals	Screw type for 2 x 0,5 – 3,5 mm ²

Wiring diagrams

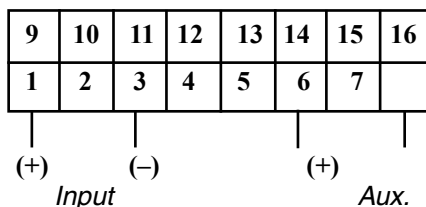

Environmental

Working Temperature	0 - 60 °C
Function Temperature	-25 till +70 °C
Storage Temperature	-55 till +85 °C
Temperature coefficient	0.01% per °C
Relative humidity	0 - 95% non condensing

Typ:		M 300
Flange	mm	96 x 48
Housing	mm	96 x 48 x 98
Cut out	mm	92 x 45
Display		3½ 1999 full scale
Digits	mm	14.2 red
Decimal point		Internally selectable
Polarity		Automatic indicating (-) inputs
Accuracy		±0.05% of reading ± 1 digit
Update response time		< 1 sek
Test Voltage	V~	4000
Weight	ca kg	0.4

DC Voltage

Range	Type	Impedance
± 50, 60, 75, 100, 150 mV	M 300-VD1	> 100 kΩ/V
± 50.....1999 mV	M 300-VD2	> 100 kΩ/V
± 2.....199.9 V	M 300-VD3	10 kΩ/V
± 200....600 V	M 300-VD4	10 kΩ/V

DC Current

Range	Type	Voltage drop
± 1, 5, 10, 20 mA	M 300-AD1	20 mV
± 100.....199.9 µA	M 300-AD2	20 mV
± 20 mA.....10 A	M 300-AD3	20 mV
4-20 mA	M 300-AD4	20 mV

AC Voltage

Range	Type	Impedance
0-600 V	M 300-VAD	10 kΩ/V

DC Current

Range	Type	Burden
1 eller 5 A (0.2 - 10A)	M 300-AAD	< 2 VA

Frequency

Range	Type
35.....199.9 Hz	M 300-HZD

Overload

Voltage	1.5 x continuous 4 x 1 second
Current	4 x continuous 25 x 1 second

Auxiliary power supply

AC	115, 230 or 400 V ± 25% 45 - 65 Hz Belastning: < 2 VA
DC	24, 48 or 110 V ± 20% Galvanic isolation. Burden : < 3 W

POSITION INDICATORS

Symbols

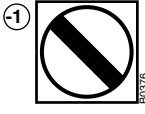
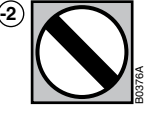

 ⊗ = Suffix

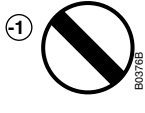
Bar

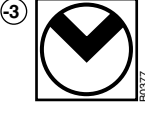
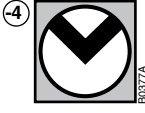

Bar

Angle

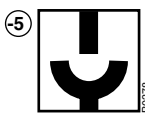

Disconnecter

Valve
 SPAW (Amber-White)
 SPRG (Red-Green)

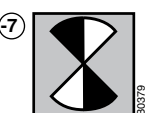
SPAW SPRG





Order example

Type	Front flange size	Symbols (Suffix)				
PI (DC)	24 = 24 x 24	PI 24	PI 25	PI 29	PI 36	PI 39
PIR (AC)	25 = 25 x 25	-1	-1	-1	-1	-1
	29 = Ø29	-2	-2		-2	
	36 = 36 x 36	-3	-3	-3		
	39 = Ø39	-4	-4	-4		
		-5	-5		-5	
		-6	-6			
		-7	-7			





Type designation = **PI 36 - 2**

Technical information

For DC aux. voltage

Type		PI 24	PI 25	PI 29	PI 36	PI 39
Front Flange	mm	 24 x 24	 25 x 25	 Ø 29	 36 x 36	 Ø 39
Housing	dia mm	21.8	21.8	21.8	21.8	21.8
Voltage	DC	24-230 V	24-230 V	24-230 V	24-230 V	24-230 V
Test voltage	kV	3.7	3.7	3.7	3.7	3.7
Power consumption W	110/230 V	0.4/1.4	0.4/1.4	0.4/1.4	0.4/1.4	0.4/1.4
Weight	Kg	0.1	0.1	0.12	0.15	0.15

For AC aux. voltage

Typ		PIR 24	PIR 25	PIR 29	PIR 36	PIR 39
Front Flange	mm	 24 x 24	 25 x 25	 Ø 29	 36 x 36	 Ø 39
Housing	dia mm	21.8	21.8	21.8	21.8	21.8
Voltage	AC	24-230 V	24-230 V	24-230 V	24-230 V	24-230 V
Test voltage	kV	3.7	3.7	3.7	3.7	3.7
Power consumption VA	110/230 V	0.4/1.4	0.4/1.4	0.4/1.4	0.4/1.4	0.4/1.4
Weight	Kg	0.1	0.1	0.12	0.15	0.15

Position Indicators

Position Indicators are used to indicate the position of circuit breakers and isolators. Cewe Instrument also produce special versions of Position Indicators for the indication of positions of valves. These indicators have type designations RG (RedGreen) and AW (Amber-White). The Position Indicators are for mounting in instrument panels or in Mimic panels.

Measuring movement

A moving magnet system is used in the Position Indicator. The movement is designed to achieve good precision of the position of the indicator disc and also to have low energy consumption. External zero-setting of the indicator disc is not required for this type of movement.

Connection

Cewe Instruments Position Indicators can be connected to DC or AC voltages between 24 and 230 V. Two voltage ranges are available.

Connection is made with screw connectors having a max. connection area of 1.5 mm².

See connection diagram.

Indicators for AC voltage

The indicators are made for DC voltage as standard. For connection to AC voltage a rectifier is connected in the indicator. The type designation for Position Indicators for connection to AC voltage is PIR.

Standards

The Position Indicator is made according to the following standards:

Personal safety EN 61010-1

Category III Table D12 Double isolation.

Max. working voltage 300 V.

IEC 51, EN 50081-1, EN 50082-1,

EN 5008 1-2, EN 50082-2, IEC 473.

Casing

Polycarbonate UL 94 VO

Enclosure code IP 54

Panel (standard) 0 – 12 mm

Accessories Art No.

Mounting tool 201100

For mosaic(Mimic panels)

Nut 121802

Sleeve 121701

Connection diagrams

Connection 3 = 24-90 V DC/AC

Connection 4 = 91-230 V DC/AC

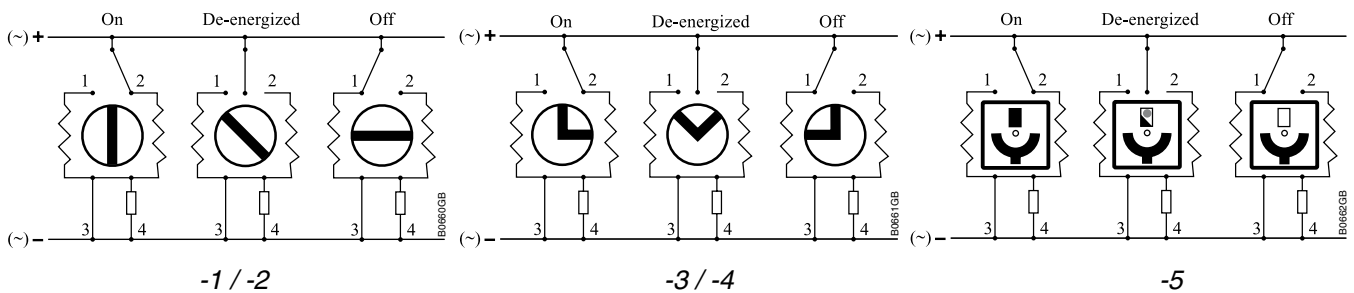

SYNCHRONIZING INSTRUMENTS

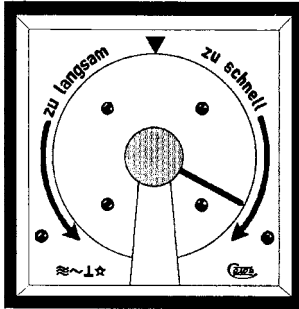

Pointer synchroscope

Type		SY 96 S	SY 144 S
Front flange	mm	96 x 96	144 x 144
Housing	mm	91 x 91	136 x 136
Internal consumption: (at 100 V, 50 Hz)			
At main side:	VA	4	4
At generator side:	VA	0.7	0.7
Weight	kg	1.0	1.1
Rated voltage:		100-110 V 230 V 400 V 440 V	100-110 V 230 V 400 V 440 V

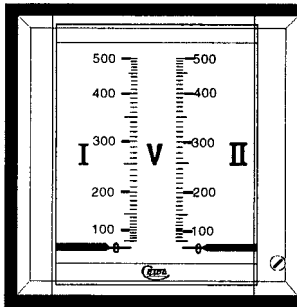

Double voltmeter

Type		WQ 96/2S	WQ 144/2S
Front flange	mm	96 x 96	144 x 144
Housing	mm	91 x 91	136 x 136
Scale length	mm	70	105
Class		1.5	1.5
Internal consumption per measuring system at 100 V	VA	1.8	2.5
Test voltage	V~	2000	2000
Weight	kg	1.2	1.5
Rated voltage		2 x X/100-110 V 2 x 230 V 2 x 400 V 2 x 440 V	2 x X/100-110 V 2 x 230 V 2 x 400 V 2 x 440 V

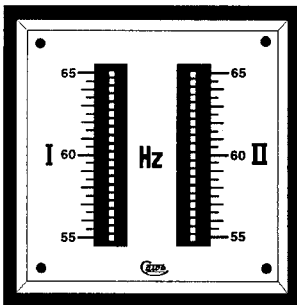

Double frequency meter

Type		FQ 96/2	FQ 144/2
Front flange	mm	96 x 96	144 x 144
Housing	mm	91 x 91	136 x 136
Class		0.5	0.5
Number of reeds		2 x 21	2 x 21
Internal consumption at 100 V	VA	1.1	1.1
Test voltage	V~	2000	2000
Weight	kg	0.6	1.0
Rated voltage		2 x 100-110 V 230 V 400 V 440 V	2 x 100-110 V 230 V 400 V 440 V
Measuring range	Hz	45—50—55 55—60—65	45—50—55 55—60—65

Wiring diagrams

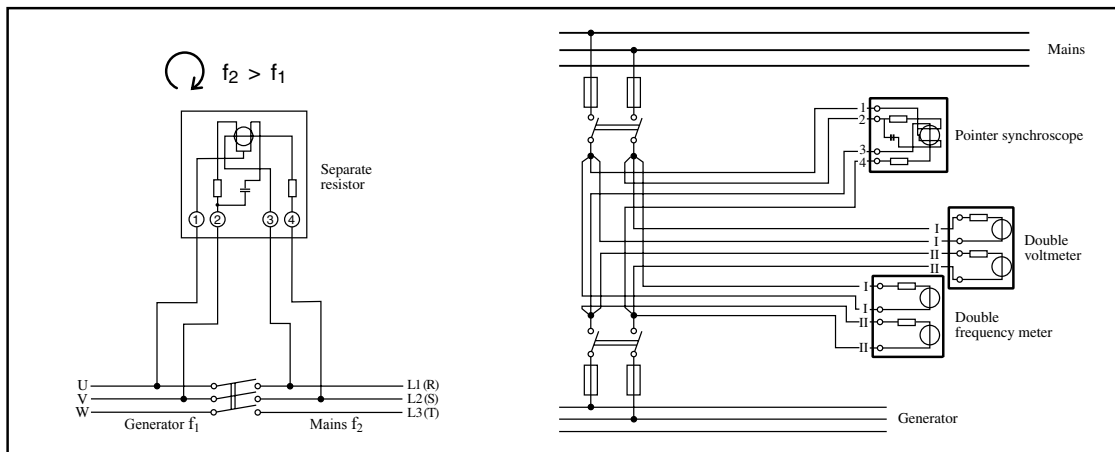

When an A.C. generator is to be connected to another generator or to the mains, voltage phase and frequency must coincide. By the measurement of these quantities the following three instruments can be used in combination.

A Pointer synchroscope

A circular scale instrument, with a shielded electrodynamic movement. The instrument indicates the phase difference between the three-phase systems. When generator frequency is lower than mains frequency, the pointer rotates counter-clockwise and at a higher frequency clockwise. At an equal frequency the pointer does not move and the position corresponds to the phase difference. The two 3-phase systems can be connected when the pointer is in a vertical position pointing at the mark, if the voltages are equal at the same time.

B Double-voltmeter

The instrument is provided with two independent moving iron movements for voltage measurement.

C Double frequency meter

The instrument is equipped with two independent reed frequency meters.

VOLTMETERS FOR SYNCHRONIZATION



This unit is a moving iron zero voltmeter with expanded scale at the beginning.

The instrument, also provided with a lamp, is intended for synchronization purposes. The principle is described in the connection diagram.

The scale has red field narrowing towards zero. The field closest to zero is black. With the pointer in the field and with a dark lamp synchronization is possible.

Type		ZQ 72	ZQ 96
Front flange	mm	72 x 72	96 x 96
Housing	mm	67 x 67	91 x 91
Scale length	mm	67	103
Frequency range	Hz	15-65	15-65
Test voltage	V~	4300	4300
Weight	ckg	0.3	0.4

Voltage

2 x 110 V, 2 x 230 V, 2 x 400 V, 2 x 440 V

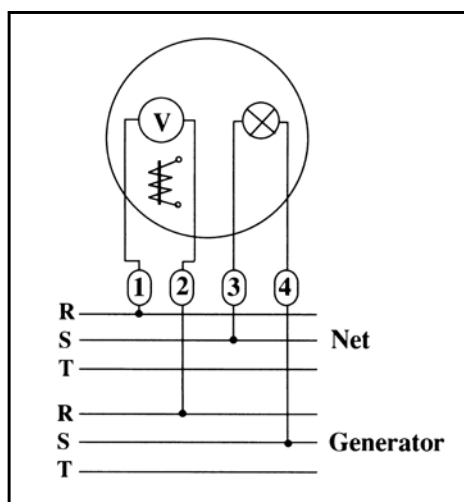

INSTRUMENT ACCESSORIES

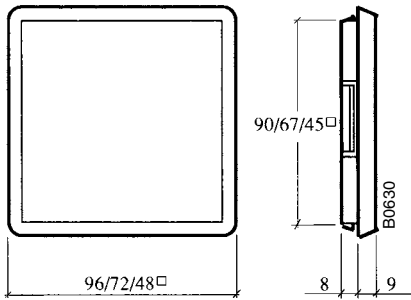

Cut-out cover

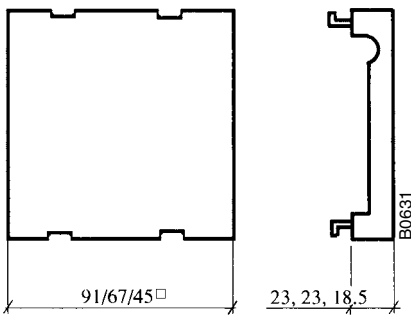

Protection cover

Type	For front size	Art. No.
Cut-out covers, black	96 x 96 mm	65 04 02
	72 x 72 mm	67 44 02
	48 x 48 mm	67 47 02
Protection covers	96 x 96 mm	11 19 01
	72 x 72 mm	11 29 01
	48 x 48 mm	11 39 01
Rubber seals	96 x 96 mm	16 33 00
	72 x 72 mm	17 27 00
	48 x 48 mm	16 34 00
Mounting frame^{*)}	96 x 96 mm	11 95 01
	72 x 72 mm	11 95 02
	48 x 48 mm	11 95 03

^{*)} For installation of 3 instruments in one aperture 284 x 92, 212 x 68, 141 x 45 mm respectively.

Wall brackets

For installation of synchronizing measuring instruments size 96 x 96 mm or 144 x 144 mm.

The bracket can be turned 180°.

Type A

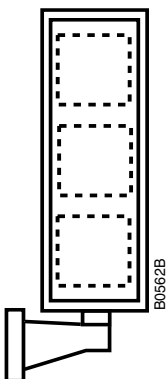

Type B

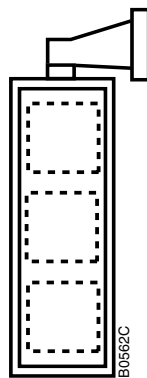

Type C

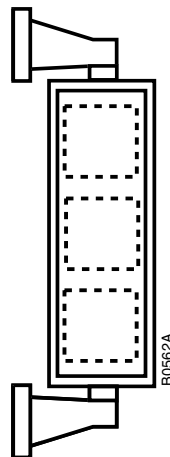

Type D

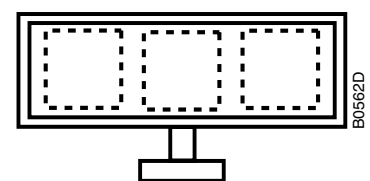

SCALE TYPES

Moving iron instruments

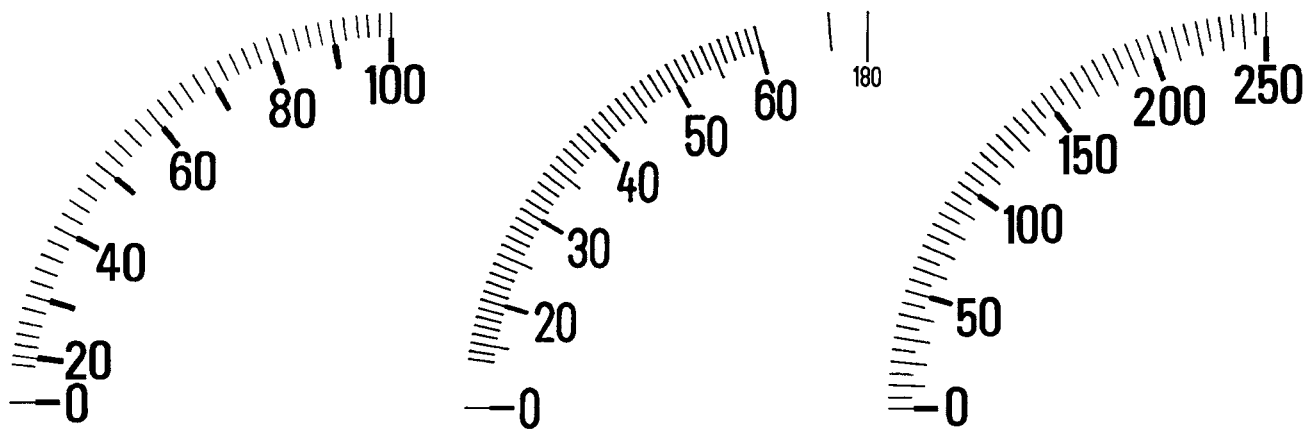

80368

Moving coil instruments

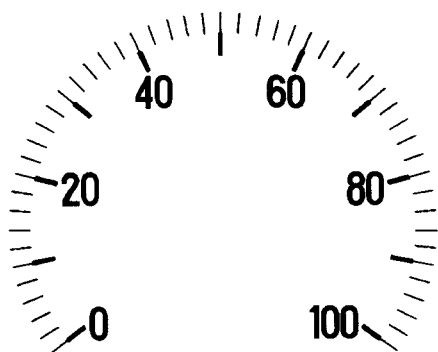

Moving coil instruments, edgewise scale

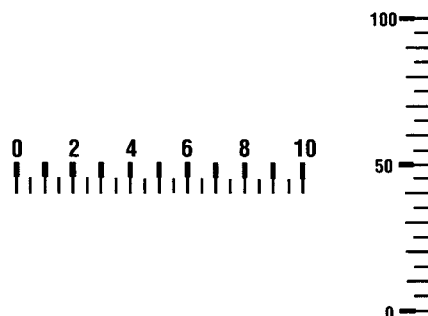

DIMENSIONS

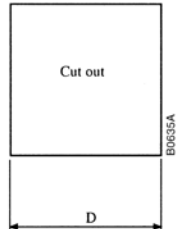
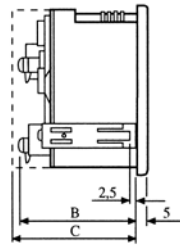
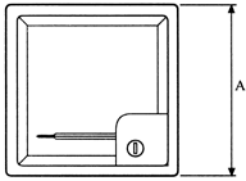

Type	Dimensions mm			
	A	B	C	D
IQ 48, CQ 48, CQR 48	48 x 48	62.5	66.5	45 x 45 +0.6
QB 48	48 x 48	57.0	66.5	45 x 45 +0.6
CL 48, CLR 48	48 x 48	63.5	66.5	45 x 45 +0.6
CL 72, CLR 72, CQ 72, CQR 72, IQ 72, IQB 72, QB 72, FQ 72	72 x 72	63.5	67.5	68 x 68 +0.7
CL 96, CLR 96, CQ 96, CQR 96, IQ 96, IQB 96, QB 96, PFL 96, PFQ 12, -13, FQ 96	96 x 96	59.5	63.0	92 x 92 +0.8
FL 96, PQ 12-34, QQ 13-33	96 x 96	97.0	100.5	92 x 92 +0.8

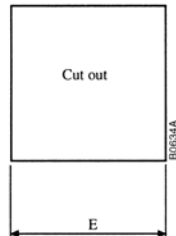
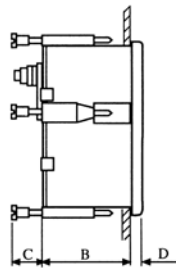
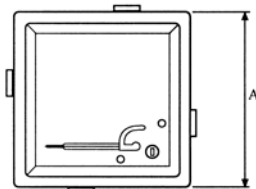

Type	Dimensions mm				
	A	B	C	D	E
SY 96S	96 x 96	100	19	5	92 x 92+0,8
SY144S	144 x 144	103	14	7	138 x 138+1.0
WQ 96/2	96 x 96	100	15	5	92 x 92+0,8
WQ 144/2S	144 x 144	118	3	7	138 x 138+1.0
FQ 96/2	96 x 96	53	-	5	92 x 92 +0.8
FQ144/2	144 x 144	49	3	7	138 x 138+1.0

PI, PIR

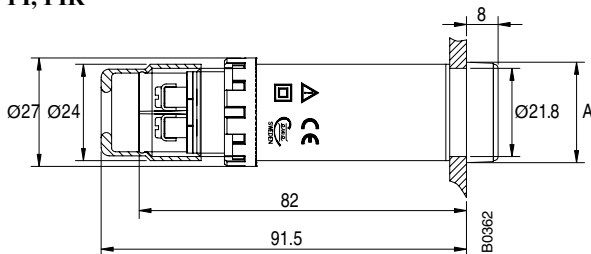

Type	A mm
PI 24, PIR 24	24 x 24
PI 25, PIR 25	25 x 25
PI 29, PIR 29	Ø 29
PI 36, PIR 36	36 x 36
PI 39, PIR 39	Ø 39

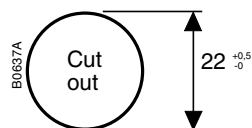

M 300-

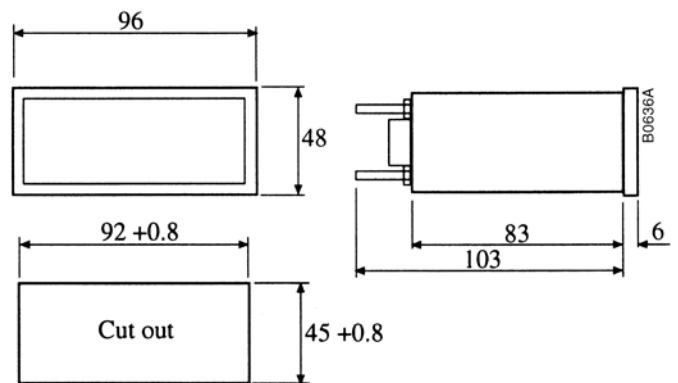

SHUNTS

Voltage drop: 60 mV ± 0,5% **Shunts with voltage drops 75, 100, 120, 150**
Material: Manganin resistance rods, **and 300 mV can also be delivered.**
Surface treatment: Nickel plated

Current A	Art. No.	Fig	Dimensions mm											
			L	L1	L2	L3	B	Bl	T	Tl	H	D	Dl	
5	6105	1	140	115	95	78	30	20	8	16	25	M5	M5	KJ-3
10	6106	1	140	115	95	78	30	20	8	16	25	M5	M5	KJ-3
15	6107	1	140	115	95	78	30	20	8	16	25	M5	M5	KJ-3
20	6108	1	140	115	95	78	30	20	8	16	25	M5	M5	KJ-3
25	6109	1	140	115	95	78	30	20	8	16	25	M5	M5	KJ-
			L	L1	B	C	K	H	T	D				
30	6110	2	95	78	20	—	10	—	8	M8				
40	6111	2	95	78	20	—	10	—	8	M8				
50	6112	2	95	78	20	—	10	—	8	M8				
60	6113	2	95	78	20	—	10	—	8	M8				
75	6114	2	95	78	20	—	10	—	8	M8				
100	6115	2	95	78	20	—	10	—	8	M8				
150	6116	2	95	78	20	—	10	—	8	M8				
200	6117	3	145	105	30	—	15	30	10	M12				
250	6118	3	145	105	30	—	15	30	10	M12				
300	6119	3	145	105	30	—	15	30	10	M12				
400	6120	3	145	105	30	—	15	30	10	M12				
500	6121	3	145	105	40	—	20	30	10	M16				
600	6122	3	145	105	40	—	20	30	10	M16				
700	6123	3	145	105	50	—	25	30	10	M16				
800	6124	3	145	105	50	—	25	30	10	M16				
900	6125	3	165	115	60	—	30	40	10	M20				
1000	6126	3	165	115	60	—	30	40	10	M20				
1200	6132	4	165	115	90	48	21	40	10	M16				
1500	6127	4	165	115	90	48	21	40	10	M16				
2000	6128	4	165	115	90	48	21	40	10	M16				
2500	6129	4	165	115	120	60	30	40	10	M20				
3000	6130	4	165	115	120	60	30	40	10	M20				
4000	6131	4	165	115	120	60	30	40	10	M20				
6000	6133	5	165	115	120	60	30	80	20	M20				
8000	6134	5	165	115	120	60	30	80	20	M20				
10000	6135	5	185	135	154	2x52	25	140	30	M20				
12000	6136	5	185	135	154	2x52	25	140	30	M20				
15000	6137	5	185	135	206	2x52	25	140	30	M20				

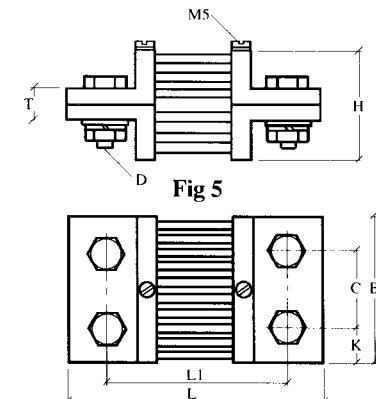
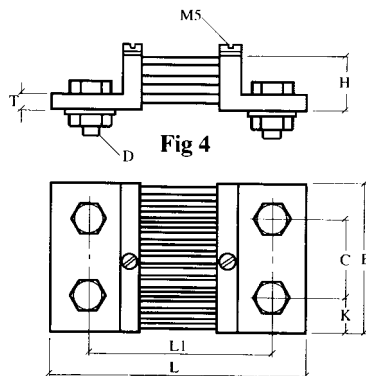
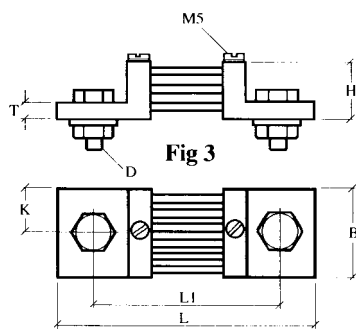
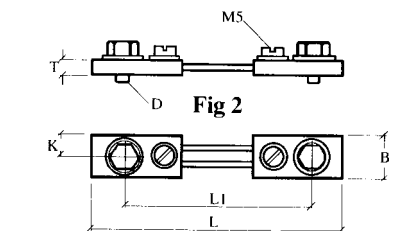
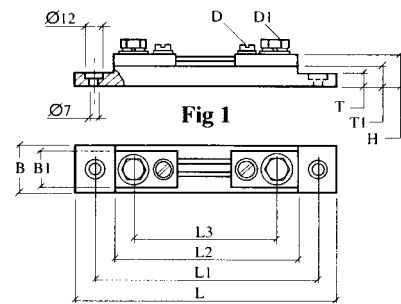



Cewe Instrument AB

Box 1006 • SE-611 29 Nyköping • SWEDEN

Tel: +46 155 775 00 • Fax: +46 155 775 97

e-mail: info@ceweinstrument.se • www.ceweinstrument.com

